

IXL MURRAY FIREPIT ASSEMBLY INSTUCTIONS

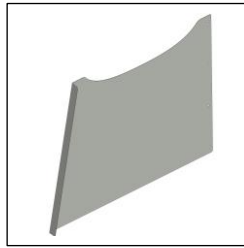

Fire pit Dish x 1



Stand Sides x 3

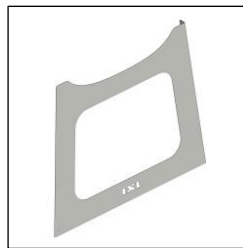

Front Side x 1

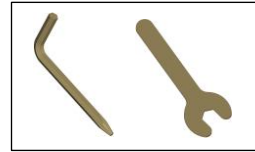

Screw driver x 1
M5 Spanner x 1

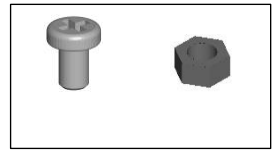

M5 Bolt x 16
M5 Hex Nut x 16

Assemble the stand sides with flange on the inside and insert screws from outside with nuts on the inside of the base.

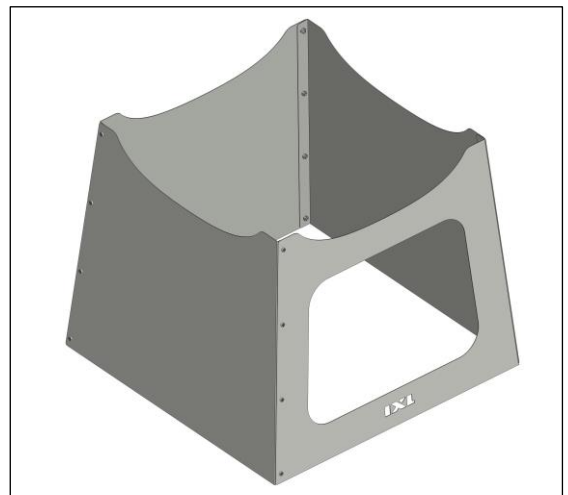
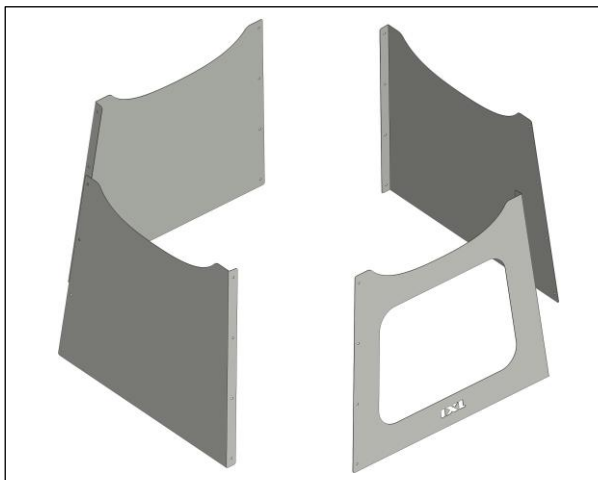
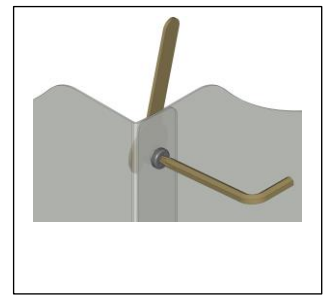
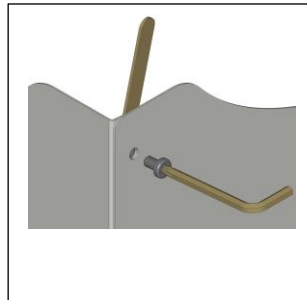

Place fire pit in top of stand as shown in diagram.

- * Gloves are to be worn when assembling fire pit.
- * Panels may have sharp edges.
- * Only finger tighten nuts until all bolts have been inserted. Use supplied tools to secure fixings.
- * This fire pit is made from Australian mild steel and is designed to go rusty over a period, some panels may have commenced this process when purchased.

FOR USER GUIDE PLEASE GO TO WWW.IXLAPPLIANCES.COM.AU